

USER MANUAL

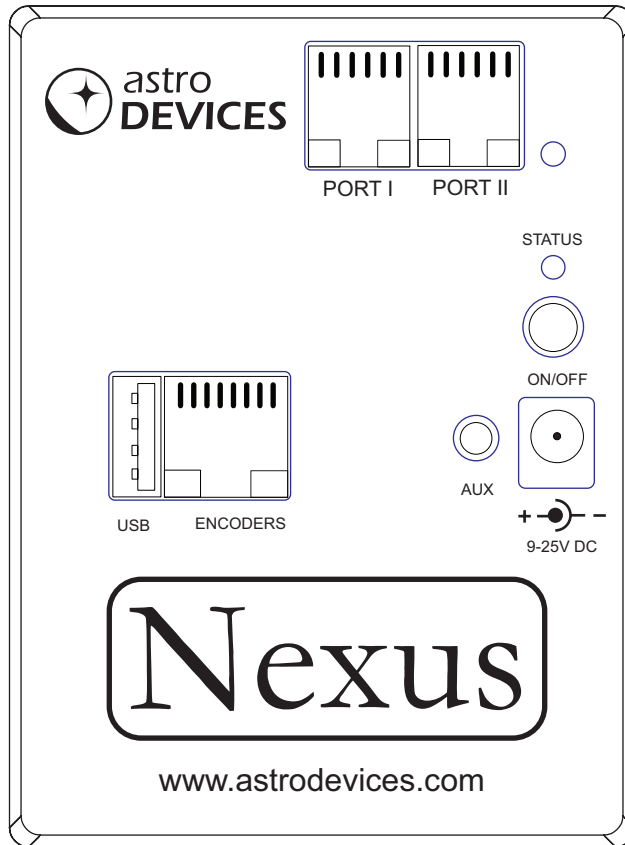

User Guide for Nexus

Version 1.9
Firmware version 2.x.x
Last revised on February 10th, 2014
Printed in Australia

Copyright

Copyright © 2012-2014, Astro Devices. All rights reserved.

No part of this manual may be reproduced or transmitted in any form for any purpose other than the purchaser's personal use, without the express written permission of Astro Devices.

Astro Devices reserves the right to make changes and improvements to its product without providing a notice.

Precautions and Safety

Electricity



Do not handle power plug and adapter with wet hands. Electrical shock may result.

Immediately power off the product and unplug the DC adapter and/or batteries if smoke or odours emit from the product.

Immediately power off the product and unplug the DC adapter and/or batteries if water or other liquids are present.

Product



Do not drop or subject the device to impact.

Keep it away from harsh environments including humid, dusty, and smoky areas.

Do not use excessive force on the connectors or attempt to disassemble the device.

Do not place heavy objects on the product. Damage to your products may result from improper use.

Technical Support

Astro Devices
198 The Esplanade,
SYLVANIA, NSW 2224
AUSTRALIA
ABN 75 270 616 917
E-Mail: support@astrodevices.com
Website: <http://www.astrodevices.com>

Thank you

Thank you for purchasing Nexus WiFi electronic telescope interface. We hope you enjoy it! This user manual will get you started and help you make the most of your Nexus.

Introduction

Nexus is a computerised WiFi wireless adapter for your telescope. It works with most popular telescopes – on equatorial or Alt-Azimuth mounts.

Nexus can be configured to function as a DSC and/or RS232 to WiFi adapter.

Nexus, a 9V battery, two optical encoders, cable and a tablet or computer will transform your telescope into a computerised telescope making locating all those hard to find objects an easy task. Also Nexus communicates wirelessly with your tablet or personal computer so you will find no wires to trip over in the darkness.

You will need [planetarium software](#) in order to use Nexus.

Product Features

Below is a short outline of main features of your Nexus.

- Supports extended Ouranos, Bbox, Sky Commander and ServoCAT communication protocols
- Handles TTL quadrature optical encoders with practically unlimited number of pulses per second
- Dual power source – internal 9V battery or external 9-25V DC
- Operating temperature range from -20 °C to +50 °C (-5 °F to +120 °F)
- Humidity 10%-90% non-condensing
- FCC / CE/ IC certified 2.4GHz IEEE 802.11b/g transceiver
- Supports Access Point and infrastructure WiFi networks
- Supports WPS (WiFi Protected Setup)
- Secure Wi-Fi authentication schemes (WEP/WPA/WPA2)
- Class I WiFi device (up to 150 meters)
- Uses 2412 ~ 2484MHz Unlicensed ISM band (channels 1-14)
- Two RS232 ports
- USB providing up to 1A, 5V power
- Uses a 32-bit MIPS CPU.
- Power consumption (without encoders connected) – 55 mA from 9V batteries or 45 mA from 12V DC external power
- Reverse polarity protection
- RoHS compliant

System Requirements

Nexus uses a WiFi communication module and requires one of the following to be connected to:

- iOS devices (iPhone, iPad, iPod touch) running iOS 3.0+
- Android devices with WiFi support
- PC with WiFi support (running Windows XP or Windows 7).
- Apple computers with WiFi support (running Mac OS X).

Please also refer to the system requirements for your favourite [planetarium software](#).

Package Content

The package contains:

- Nexus
- User manual
- Wall mount panel with screws
- RJ45 to DB9 converter
- RJ45 to RJ12 cable
- DC 2.1mm to cigarette lighter power cable

For using Nexus in the field we advise on using rechargeable batteries or external power source.

Controls

All controls are situated on front panel of Nexus:

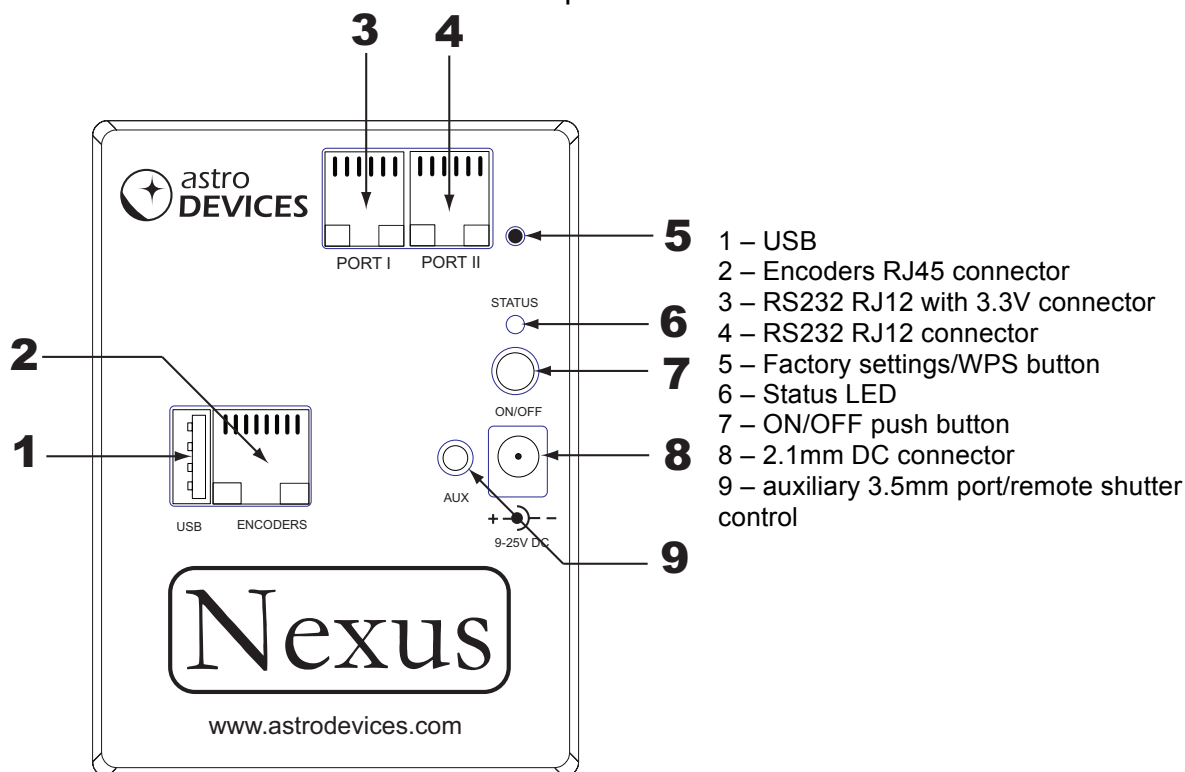

WARNING:

Do not connect Nexus to an external power source that is not within the specified voltage range. Nexus has internal over-current protection but it is safer to use it with the power source specified. The USB port can be used to charge your portable computing device and Nexus can provide up to 1A.

Do not charge your portable device from the USB port while Nexus is powered by 9V internal battery!

The status LED reports different states of Nexus:

Blinking type	Description
Fast pulsating blinking (once a second)	A computing device is connected to Nexus or Nexus is connected to a WLAN
Slow pulsating blinking (once every two seconds)	Nexus is not connected
ON	Updating firmware
Flashing (once a second)	Error/Change Mode

Connecting Nexus to Your Telescope/Other Devices

Nexus can operate in various modes:

- Wireless DSC
- Wireless DSC connected to ServoCat
- Wireless DSC and Serial / USB to WiFi adapter
- Serial to WiFi adapter

Wireless DSC

The following diagram illustrates how Nexus is connected to a telescope:

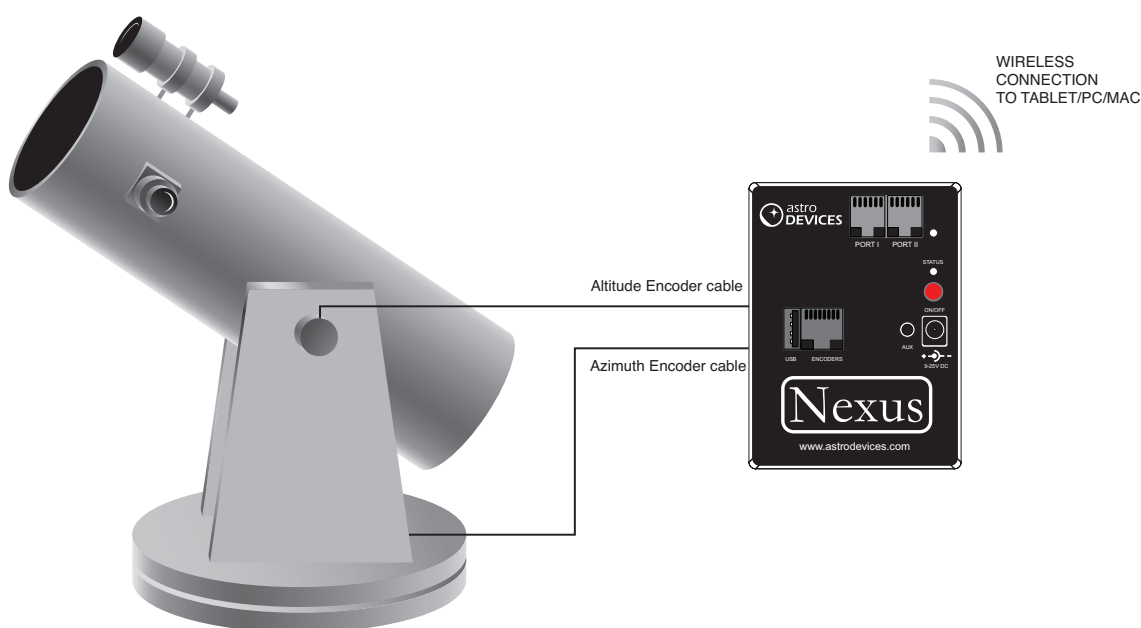

Nexus constantly detects pulses sent by the encoders and translates them into absolute angular positions. Planetarium software periodically (depending on the settings) requests current encoders' position and converts it to real sky coordinates. Then the position of the telescope is usually reflected on the screen by a cross hair. An alignment procedure needs to be performed before the planetarium software can start showing where the telescope is pointing. Please refer to the user manual of the planetarium software for details on performing the alignment procedure.

Please note that the connection to a telescope mounted on equatorial mount is the same except the Azimuth cable is connected to the RA (right ascension) encoder while the Altitude cable is connected to the Declination encoder.

Wireless DSC with non-USB ServoCAT

The following diagram shows how Nexus should be connected when used together with ServoCAT:

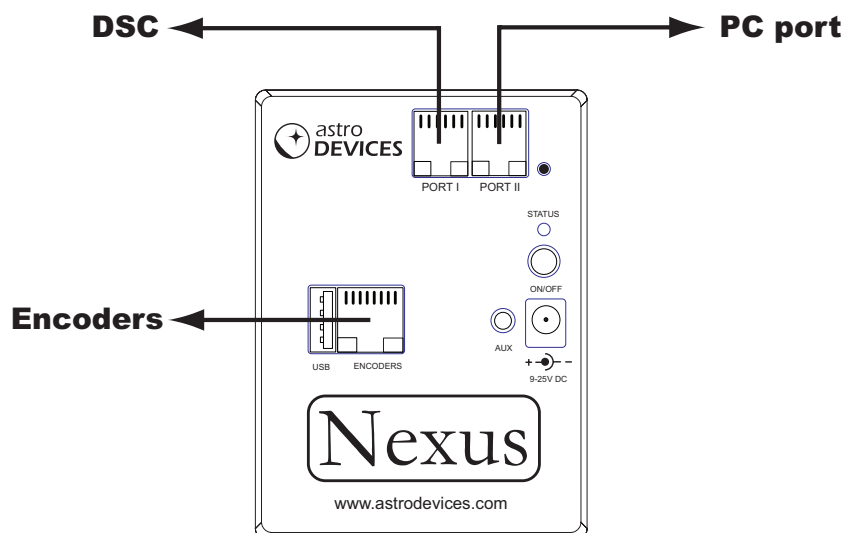

Where 'DSC' and 'PC Port' are the names of the ports on ServoCAT. Please note that a two star alignment should be performed before ServoCAT can track and execute goto commands.

Wireless DSC with USB ServoCAT

The following diagram shows how Nexus should be connected when used together with a USB version of ServoCAT:

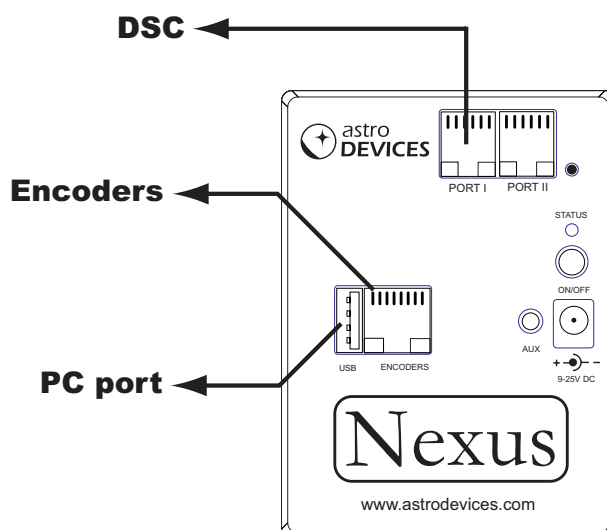

Where 'DSC' and 'PC Port' are the names of the ports on ServoCAT. Please note that a two star alignment should be performed before ServoCAT can track and execute goto commands.

Wireless DSC and Serial/USB to WiFi adapter

Nexus can be used as a wireless DSC and serial to WiFi adapter. In this mode Nexus is used for a 'push-to' DSC on a telescope while Port I, Port II and USB can be connected to other telescopes/devices.

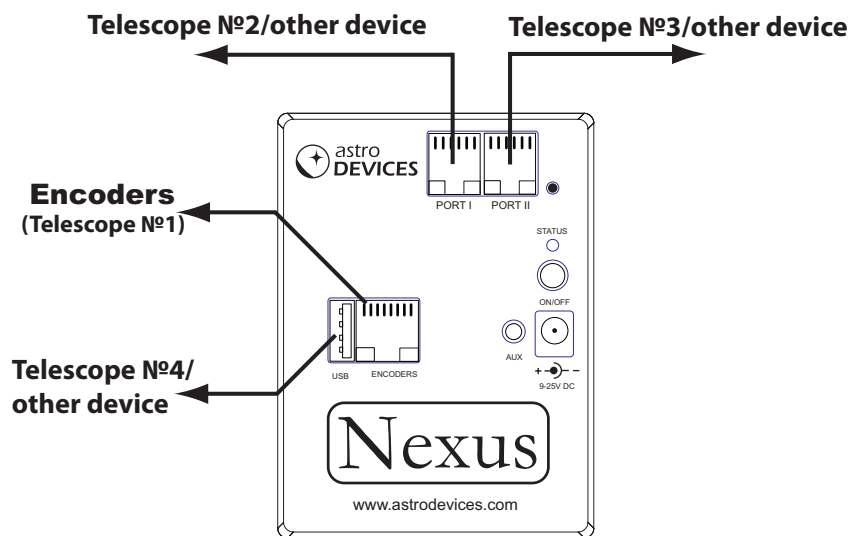

Serial to WiFi adapter

In this mode the 'Encoders' port is not used. Port I and Port II can be connected to telescope(s)/other device(s) and Nexus functions as a serial to WiFi adapter.

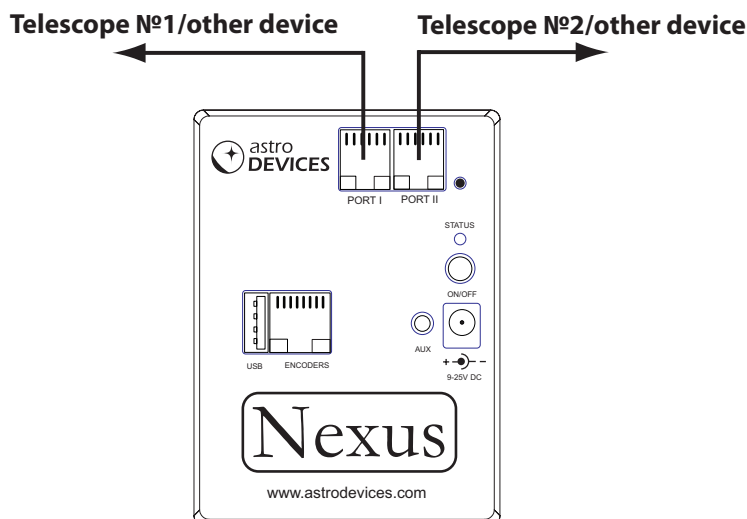

USB Serial to WiFi adapter

In this mode only the USB port is used. The USB port is connected using a standard USB cable to a telescope with a USB interface, Nexus supports a number of telescopes with a USB interface based on FT232x (ServoCAT, SiTech), CP210x (iOptron) and PL2303 (iOptron, Meade) chips.

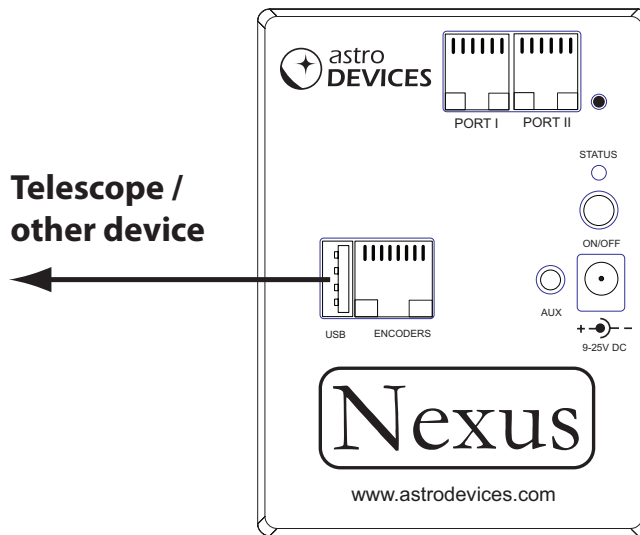

Ports Pin Descriptions

Encoders

Nexus has a standard RJ-45 connector to connect it to rotary encoders of your telescope. The pins are numbered according to the following diagram:

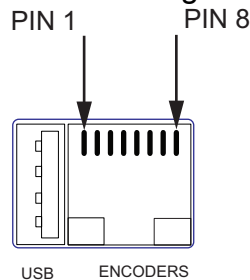

The pin descriptions are in the following table:

Pin	Description
1	Channel B of Azimuth or RA encoder
2	+5 V
3	Channel A of Azimuth or RA encoder
4	Ground
5	Channel B of Altitude or Declination encoder
6	+5V
7	Channel A of Altitude or Declination encoder
8	Ground



WARNING:

Nexus's encoders' inputs do NOT have input protection, care must be taken not to exceed the maximum input voltage of +5V DC on any input, and the inputs should never be driven to negative voltages below GROUND. This will cause permanent damage to the internal circuits of Nexus.

Nexus only works with TTL (Transistor-Transistor Logic) [rotary encoders](#) with quadrature output.

RS232 ports (Port I and Port II)

Nexus has two RS-232 ports. It uses a standard RJ-12 connector. The pins are numbered according to the following diagram:

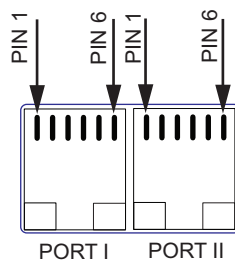

The pins description is as follows:

Port	Pin	Description
Port I	1	Ground
	2	TxD – transmitted data (output)
	3	RxD – received data (input)
	4	Ground
	5	Ground
	6	+3.3V (up to 500mA)
Port II	1	Ground
	2	TxD – transmitted data (output)
	3	RxD – received data (input)
	4	Ground
	5	Ground
	6	No connection

Auxiliary Port

The port can be used to control the shutter release of DSLRs. The port uses a standard 3.5mm TRS jack. The following diagram shows the pin numbering for the 3.5mm TRS plug to be used with the port:

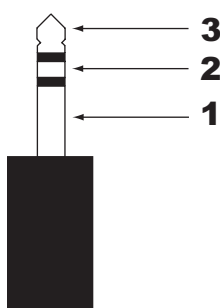

The pins' description to shutter control is as follows:

Pin	Description
1	Ground
2	Focus
3	Shutter release

Connecting To Tablet/PC/Mac

Nexus communicates with planetarium software using one or more TCP/IP ports. Nexus's default TCP/IP ports' configuration is described in the following table:

TCP/IP port	Port	Connection	Serial port parameters, baudrate, data bits, stop bits, parity
DSC mode			
4060		Astro Devices communication protocol	
4061		Sky Commander communication protocol	
4062		ServoCAT communication protocol	
4070		Configuration protocol	
	Port I	Sky Commander communication protocol	19200, 8, 1, no
	Port II	ServoCAT communication protocol	19200, 8, 1, no
	USB	ServoCAT communication protocol	19200, 8, 1, no
DSC+Serial to WiFi			
4060		Astro Devices communication protocol	
4061		Port I	9600, 8, 1, no
4062		Port II	9600, 8, 1, no
4063		USB	9600, 8, 1, no
4070		Configuration protocol	

Nexus is operating in Access Point mode by default. The default SSID of Nexus is **AD_Nexus_XXXXX** where **XXXXX** is the serial number of your Nexus. The serial number is printed on the back of your Nexus. The SSID can be changed using the configuration utility.



The default IP address of your Nexus is **10.0.0.1**.



Note: The WiFi Configuration setup may differ based on the brand of the computer used and on the OS running on that device. Please refer to the user manual of the devices and the OS. The TCP/IP port used for configuration is always 4070 and cannot be changed.

Please refer to the user manual of your planetarium software for the explanation on setting up the communications with telescope. Some software is designed to operate a telescope directly through a serial port. You can use a special utility –

virtual serial port driver for your computer. A number of utilities of this type is available with many of them free:

[COM2TCP](#) - with a 45-day free trial, by [AstroGeeks](#)
[HW VSP 3](#) - Free for personal use

Operating Nexus

Updating Firmware

Nexus's firmware can be updated using a USB memory stick. Please download the latest firmware from the support section of our website and copy it to the root folder of the USB memory stick. Please follow these steps:

- Turn Nexus OFF
- Insert the USB memory stick into USB connector of Nexus
- Press and hold the 'Factory Setting' button
- Turn Nexus ON
- Wait for two seconds
- Release the 'Factory Setting' button
- The firmware will be updated. Once the update is complete the Status LED will start 'pulsating' blinking
- Turn Nexus OFF
- Remove the USB memory stick

Please note that Nexus will reset all settings with every firmware update.

Restoring WiFi factory settings

From time to time you may need to restore the WiFi settings of your Nexus. The following steps will allow you to reset them:

- Turn Nexus OFF
- Press and hold the 'Factory Setting' button
- Turn Nexus ON (the status LED will start flashing)
- Release the button
- The WiFi settings are restored as soon as the status LED will start 'pulsating' blinking



Note: Please make sure that no device is connected/joined to Nexus's WiFi network when restoring WiFi factory settings.

Connecting Nexus to a WLAN using WPS

You may connect Nexus to a WLAN using WPS. It simplifies connection of Nexus to your WLAN significantly – there is no need to specify SSID, password etc. Your WLAN router/access point must support WPS.

Please follow these steps:

- Turn Nexus ON
- Press the WPS button on your network router (or consult the user manual on how to activate WPS on your router)
- Press and hold 'Factory Setting/WPS' button for at least 2 seconds
- The status LED will start flashing
- Release 'Factory Setting/WPS' button
- Press and release 'Factory Setting/WPS' button again
- Wait until the status LED will start 'pulsating' blinking

Please consult the user manual of your network router/access point on how to determine the IP address it assigned to Nexus. In most cases the router/access point will list all devices with their assigned IP addresses on one of the status pages. Your Nexus will appear on that page as **AD_Nexus_XXXXX** where **XXXXX** is the serial number of your Nexus.

List of Compatible Planetarium Software

Nexus is compatible with most planetarium software packages that support Ouranos or Bbox protocols. You can also use planetarium software that supports ASCOM platform (<http://ascom-standards.org>). The table below lists just a few software packages that Nexus was tested with.

Software Name	Platform	Protocol	Website
Deep Sky Browser	iOS	Astro Devices Nexus	http://www.astrodevices.com/
Cartes du Ciel	Windows	Orion IntelliScope Mounts (ASCOM platform)	http://sourceforge.net/projects/skychart/
DeepSky	Windows	Orion IntelliScope Mounts (ASCOM platform)	http://www.deepsky2000.net
Hallo northern sky	Windows	Orion IntelliScope Mounts (ASCOM platform)	http://www.hnsky.org/
Megastar	Windows	Bbox/Sky Wizard CTI	http://www.willbell.com/
SkySafari Plus/Pro	Android iOS MacOS X	Basic Encoder System	http://www.southernstars.com/
Starry Night®	Windows	Orion IntelliScope Mounts (ASCOM platform)	http://www.starrynightstore.com
TheSky 6	Windows	BBox	http://www.bisque.com
Voyager-4.5	Windows MacOS X	Basic Encoder System	http://www.carinasoft.com

FREQUENTLY ASKED QUESTIONS (FAQ)

Q: I have a ServoCAT installed on my telescope. Do I need any additional devices/cables?

A: You only need two extra cables to connect Nexus to ServoCAT for a full wireless control of ServoCAT. In case of using non-USB version of ServoCAT you need two serial cables. In case of using USB version of ServoCAT you need one serial cable and one USB cable. You do not need any additional DSC. You will also need a laptop or a tablet to perform a two star alignment.

Q: How long does the battery last?

A: That depends on a number of different factors – type of encoders used, operating temperature, the type of the battery. It also depends on the mode Nexus is running in. For example, the 9V Duracell Coppertop battery will last 4-5 hours with Nexus operating as a Serial to WiFi adapter. However the same battery will last only two hours when Nexus is used as a wireless DSC with S2 optical encoders (each encoder draws up to 57mA from 5V source!).

Q: Can I use a rechargeable battery?

A: Yes, Nexus will operate with rechargeable 9V batteries (the actual voltage for them is usually 8.4V).

Q: What type of batteries is recommended for operating in cold conditions?

A: The most economical type of batteries is 12V SLA (sealed lead acid). Lithium batteries have very good performance in cold conditions but they are quite expensive. Rechargeable Lithium batteries (Li-Poly) without over discharge protection are not recommended as Nexus does not have a low voltage cut-out level and they can be discharged below the recommended level.

Q: Can I use non-optical encoders?

A: Yes, the firmware processes pulses from standard quadrature encoders. They can be optical, capacitive or magnetic encoders. Any of them can be used as long as they provide TTL level quadrature output.

Q: Does Nexus use external power when both external power and the battery are inserted?

A: Nexus uses only external power source if the 2.1mm DC plug is inserted into the external power connector.

Q: Does Nexus have a built-in charger for the installed battery?

A: No, Nexus does not charge the battery when the external power is connected to it.

Q: How can I determine the resolution of my encoder?

A: Just multiply the CPR (counts per revolution) of your encoder by four and then multiply the result by the ratio of the gears it is connected to your telescope (if you have any).

Q: Does Nexus work with a standard Android based device (without any modifications to the device's firmware)?

A: Yes, Nexus works with any recent Android based phone/tablet without any need to modify the firmware on that device. Nexus is working as a WiFi access point.

Suppliers of Encoders/Telescope Encoder kits

Nexus is compatible with most quadrature rotary encoders with TTL level outputs and powered with 5V. The following table lists just some of suppliers selling encoders or telescope encoder kits.

Supplier	Hardware	Country	Website
SUPRA Praha	Telescope encoder kits	Czech Republic	http://www.celestron.cz/
Intercon Spacetec	Encoders/ Telescope encoder kits	Germany	http://www.intercon-spacetec.de/
JMI Telescopes	Encoders/ Telescope encoder kits	USA	http://www.jmitelesopes.com/
Sky Engineering, Inc	Encoders/ Telescope encoder kits	USA	http://skyeng.com/
US Digital	Encoders	USA	http://www.usdigital.com/

Warranty

Nexus is covered by a one-year limited warranty. Please refer to the enclosed warranty certificate for full details.

Technical Support

You can find the latest version of the manual and firmware in the support section of our website. Please feel free to e-mail us should you require further technical assistance.

Technical Support

You can find software updates and user documentation on the Astro Devices website.

<http://www.astrodevices.com>

e-mail: [mailto:support@astrodevices.com?subject=Nexus support](mailto:support@astrodevices.com?subject=Nexus%20support)

FCC Statement for Nexus

Contains:
FCC ID:YOPGS1011MIPS
IC ID:9154A-GS1011MIPS

This device complies with Part 15 of the FCC Rules. Operation is subject to the following two conditions: (1) this device may not cause harmful interference, and (2) this device must accept any interference received, including interference that may cause undesired operation.

NOTE: To comply with FCC RF exposure compliance requirements, the antenna used for this transmitter must be installed to provide a separation distance of at least 20 cm from all persons and must not be co-located or operating in conjunction with any other antenna or transmitter.

NOTE: This equipment has been tested and found to comply with the limits for a Class B digital device, pursuant to Part 15 of the FCC Rules. These limits are designed to provide reasonable protection against harmful interference in a residential installation. This equipment generates, uses and can radiate radio frequency energy and, if not installed and used in accordance with the instructions, may cause harmful interference to radio communications. However, there is no guarantee that interference will not occur in a particular installation. If this equipment does cause harmful interference to radio or television reception, which can be determined by turning the equipment off and on, the user is encouraged to try to correct the interference by one or more of the following measures:

- Reorient or relocate the receiving antenna
- Increase the separation between the equipment and receiver



DECLARATION OF CONFORMITY

We, Astro Devices, ABN 75 270 616 917, 198 The Esplanade,
SYLVANIA, NSW 2224, AUSTRALIA, E-mail: info@astrodevices.com,

As manufacturer/producer declare that:

Product Name: Nexus
Product Series: NXW12
Product Description: Wireless digital setting
circles/multifunctional adapter for
telescopes

conforms to the following directives and standards therein

Directives:

WEEE- Waste from Electrical and Electronic Equipment - 2002/96/EC
Radio Equipment & Telecommunications Terminal Equipment (R&TTE) - 1999/5/EC
RoHS- Restriction of use of Hazardous Substances in Electrical and Electronic
Equipment - 2002/95/EC

Standards:

EMC: EN 55022: EN 301 489-1 V1.8.1:2008-04, EN 301 489-17 V2.1.1:2009-05
RADIO: EN 300 328 V1.7.1:2006-10
Immunity: EN 55024: EN 61000-4-2:2001, EN 61000-4-3:2002
Safety: EN 60950-1:2006+A11:2009+A1:2010

Supplementary Information:

This unit is a battery-operated appliance.

Date of issue:

January 20th 2013

Communication Protocols

Astro Devices Protocol

The following table lists the main command set supported by Nexus DSC communication protocol.

Command	Description	Example of input	Returns
V or V	Return the firmware version information	V	Astro Devices Nexus v1.0<CR>
R# #<CR> or R#<tab>#<CR>	Set encoders' resolution. Please note that the values set are not saved into flash memory and will be reset upon a power cycle.	R10000<tab>9000<CR>	R
Z# #<CR> or Z#<tab>#<CR>	Set encoders' resolution. Please note that the values set are not saved into flash memory and will be reset upon a power cycle.	Z10000 9000<CR>	*
I# # or I#<tab>#<CR>	Set initial encoders' positions	I0<tab>0<CR>	R
Q	Query encoders' positions	Q	+1888 -2190<CR>
H or r	Query encoders' resolutions	H	8192 8192<CR>
A<0 1>_<RA >_<Dec><cr>	Align on an object. Please note that the coordinates should be using epoch 2000 if Nexus is used with ServoCat.	A0_45.123_78.245<cr>	Y - success E - error
T_<0 90><cr>	Initial telescope alignment at 0 degrees (horizontal) or at 90 degrees (vertical)	AI_0<cr>	Y - success E - error
O	Release shutter	O<cr>	
o	Close shutter	o<cr>	
F	Activate 'focus'	F<cr>	
f	Deactivate 'focus'	f<cr>	
<CR>	Query the current position. The current position will be valid only once the star alignment is performed	<CR>	12.345_67.890<CR>

Where

- <CR> - carriage return (or 'Enter') character with a decimal value of 13
- <tab> - tab character with a decimal value of 9.
- _ - space character with a decimal value of 32.

Nexus Configuration Protocol

Nexus can be configured to operate in different modes. The configuration is performed by communicating with Nexus using TCP/IP port number 4070.

Each command has the following syntax:

<set/get>_<parameter 1>[_<parameter 2>]_<value><CR>

Nexus will send back the value requested or 'OK' in case of a 'set' command. The returned packet will be equal 'ERR' in case of invalid requests. The return packets are always terminated with <CR>.

The following table lists all command parameters:

Parameter 1	Parameter 2	Value	Description	Examples
WiFi configuration				
CHANNEL		0-14	Specifies the WiFi channel to be used. Please note that the value of 0 should only be used when Nexus is setup to operate in infrastructure mode.	set CHANNEL 7<cr> get CHANNEL<cr>
DHCP		0,1	Specifies whether to use DHCP: 0 – disabled, 1 – enabled	set DHCP 0<cr> get DHCP<cr>
IPADDRESS		xxx.xxx.xxx.xxx	Specifies the IP address to be used. The IP address will only be used when DHCP is disabled.	set IPADDRESS 169.254.1.1<cr>
IPMASK		xxx.xxx.xxx.xxx	Specifies the IP mask.	set IPMASK 255.255.0.0<cr>
NTYPE		0 - infrastructure 7 – Access Point	Specifies the network mode to be used by Nexus.	
PASSWORD		up to 32 bytes	Specifies the password to be used to connect to a WiFi network.	set PASSWORD Pass123<cr> get PASSWORD<cr>
SSID		up to 64 bytes	Specifies SSID	set SSID MyNexus<cr> get SSID<cr>
TRANSPower		1-12	Specifies the transmission power to be used by the WiFi module. Please note that the value of 1 specifies the minimum power and the battery will last longer at that level.	
Physical Port				
PORTI PORTII USB	baudrate	9600+230400	Sets the baud rate to be used on the port specified. The value specified is in bits per second.	set PORTI baudrate 19200<cr> get PORTII baudrate<cr>
	databits	8,9	Sets the number of data bits.	set PORTII databits 8<cr> get PORTI databits<cr>
	parity	0, 1, 2	Sets the parity to be used on the ports specified: 0 – none 1 – odd 2 – even	set PORTII parity 0<cr> get PORTI parity<cr>
	protocol	0-2	Specifies the communication protocol to be connected to the physical port 0 - Astro Devices communication protocol 1 - SkyCommander communication protocol 2 - ServoCat communication protocol	set PORTI protocol 1<cr> get PORTI protocol<cr>
	stopbits	1,2	Specifies the number of stop bits.	set PORTI stopbits 8<cr> get PORTII stopbits<cr>

Parameter 1	Parameter 2	Value	Description	Examples
Port Routing				
PORT	0÷5	1024÷65535	Sets the TCP/IP port number to be used with virtual port (0÷5)	set PORT 0 4060<cr> get PORT 5<cr>
PORTCONNECT	0÷5	0÷7	Specifies the connection type for the virtual port (0÷5), The connection type can be equal to one of the following values: 0 - Astro Devices communication protocol 1 - SkyCommander communication protocol 2 - ServoCat communication protocol 3 - Configuration communication protocol 4 - Connect to PortI 5 - Connect to PortII 6 - Connect to USB 7 - no connection	
Digital Setting Circles				
AZENCRES RAENCRES		128÷4294967296	Specifies the azimuth/RA encoder resolution. The default value is set to 10000. The value specified is in ticks per revolution. Please note that both commands (AZENCRES and RAENCRES) set the same value.	set AZENCRES 10000<cr> get RAENCRES<cr>
ALTENCRES DECENCRES		128÷4294967296	Specifies the altitude/declination encoder resolution. The default value is set to 10000. The value specified is in ticks per revolution. Please note that both commands (ALTENCRES and DECENCRES) set the same value.	set DECENCRES 8192<cr> get ALTENCRES<cr>
MOUNTERR		Z1 Z2 Z3	Specifies the mount fabrication errors in degrees.	set MOUNTERR 0.12 0.3 0.1<cr> get MOUNTERR<cr>
MOUNTTYPE		0 – Alt/Az 1 - Equatorial		set MOUNTTYPE 0<cr> get MOUNTTYPE<cr>
CONFIGURE			Saves the configuration into flash memory.	set CONFIGURE<cr>

Glossary

CPR stands for Counts Per Revolution.

PC is a personal computer. It includes computers running Windows, Linux or Mac OS.

SSID (Service Set Identifier) is the name of a wireless local area network (WLAN),

Standby mode is when the Nexus is passively waiting for a connection with a Tablet/PC.

TTL stands for Transistor-Transistor Logic

WPS stands for WiFi Protected Setup

Printed in Australia